

Manual

mc-28

16 channel HoTT 2,4 GHz transmitter

No. 33028

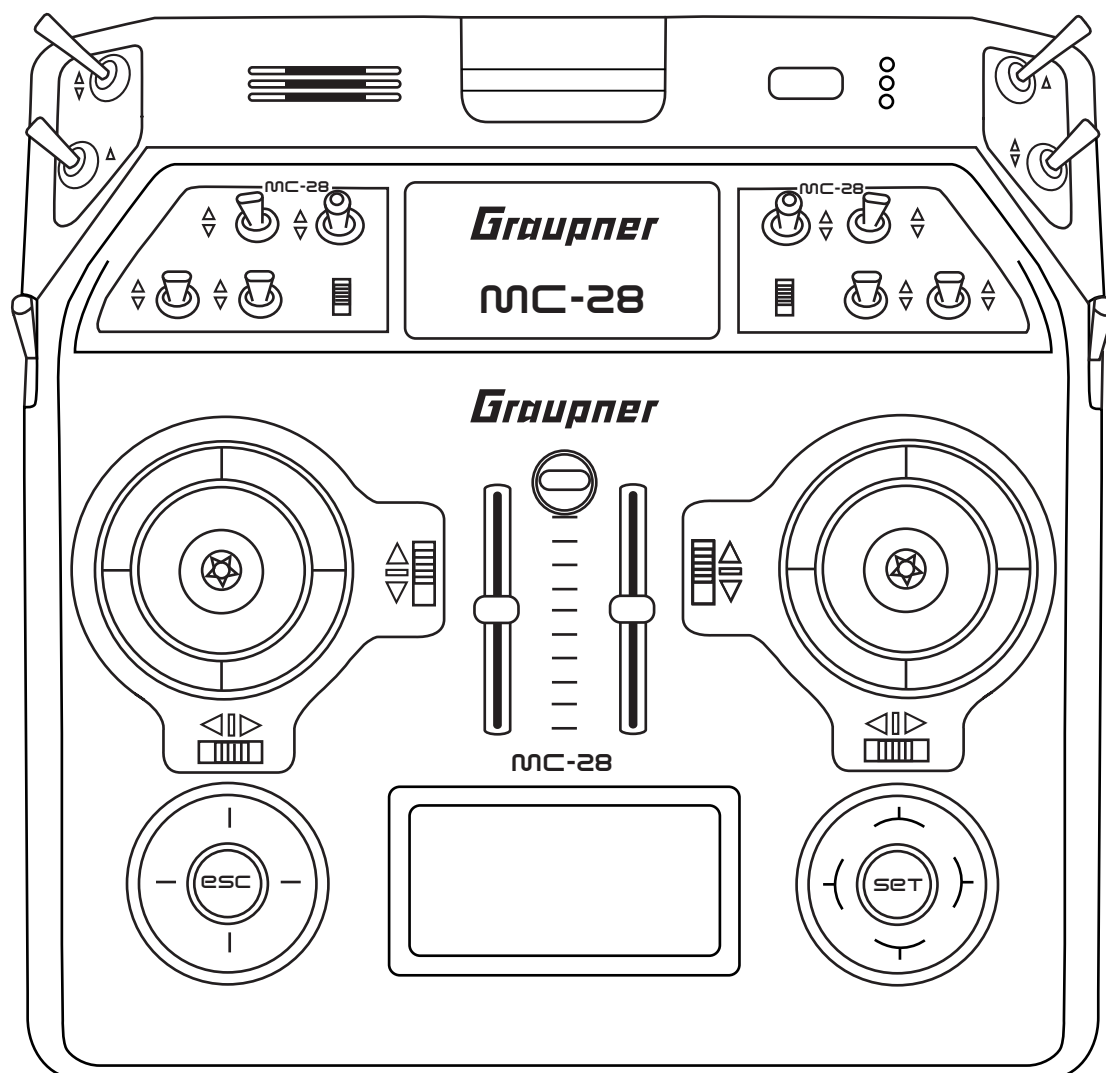

Introduction	5
Service Centre	5
Intended use	6
Target group	6
Package content	7
Technical Data	7
Symbols explication	8
Safety notes	8
For your safety by handling the transmitter	9
For your safety by handling the battery	9
Description of the transmitter	11
Control elements on the transmitter	11
Inside view	13
Interfaces	14
DSC socket	15
Memory cards	16
Display and touchpad	17
Symbols in the display	18
Key pad	19
Commissioning	20
Hand pads	20
Brackets for transmitter belt	20
Anchorage for the transmitter belt	20
Opening/closing the transmitter housing	21
Sticks conversion	22
Control sticks length adjustment	22
General commissioning	23
Binding a receiver	24
Adjust control mode	25
Charging the transmitter battery	26
Low voltage warning	27
Battery use timer in the display	27
Switch off the transmitter	27
Lithium battery	27
Use and menu functions	28
Short-Cuts	28
Hidden mode	30
Firmware update/Changing the display language	31
Telemetry data display	32

Firmware update	36
Update through memory card.....	36
Update through USB port.....	37
Problems during firmware update	37
SIMPLIFIED DECLARATION OF CONFORMITY	38
Manufactured by	38
Notes on environmental protection	39
Care and maintenance	39
Warranty	39

Introduction

Thank you very much for purchasing the **Graupner mc-28 HoTT** transmitter.

This manual is composed by two parts. Part 1 is contained in the product's package content. Part 2, the programming manual, can be found in its last version on **www.graupner.de** by the related item page.

Read both manuals carefully to achieve optimal use of your transmitter and first of all to safely control your models. If you experience any trouble during operation, take the instructions to help or ask your dealer or **Graupner** Service Centre.

Due to technical changes, the information may be changed in this manual without prior notice. Be always updated by checking periodically on our website, **www.graupner.de** to be always updated with the products and firmware.

This product complies with national and European legal requirements.

To maintain this condition and to ensure safe operation, you must read and follow this user manual and all the safety notes before using the product!



Note

This manual is part of that product. It contains important information concerning operation and handling. Keep these instructions for future reference and give it to third person in case you gave the product.

Service Centre

Graupner Central Service
Graupner/SJ GmbH
Henriettenstraße 96
D-73230 Kirchheim / Teck

Servicehotline

☎ (+49) (0)7021/722-130
Monday- Thursday
9:15 am- 4:00 pm
Friday
9:15 am- 1:00 pm

Graupner USA
3941 Park Dr Suite 20-571
El Dorado Hills, CA. 95762
US

Website: **www.graupnerusa.com**
Phone: +1 855-572-4746
Email: service@openhobby.com

Graupner in Internet

For the service centers outside Germany please refer to our web site **www.graupner.de**

Intended use

This remote-control system may only be used for the purpose specified by the manufacturer for operation of UAVs and other unmanned remote control models. Any other type of use is impermissible and may damage the system and cause significant property damage and/or personal injury. No warranty or liability is therefore offered for any improper use not covered by these provisions.

In addition, it is explicitly pointed out that you must inform yourself about the laws and regulations applicable at your respective starting point before starting the remote control operation. Such conditions may differ from state to state, but this must be followed in every case.



Notes

- In general, it is not permitted to fly over airports, factory sites, nature reserves, built-up areas, etc.
- Where designated no-fly zones are located, and which in no way affect them, it can be determined, for example, using the “Air-Map” app.

Read through this entire manual before you attempt to install or use the transmitter.

Target group

The product is not a toy. It is not suitable for children under 14 years. The operation of the **mc-28 HoTT transmitter** must be performed by experienced modelers. If you do not have sufficient knowledge about dealing with radio-controlled models, please contact an experienced modeler or a model club.

Package content

- Transmitter **mc-28 HoTT**
- Transmitter battery
- Receiver (optional)
- USB Adapter/Interface
- USB cable
- Micro SD card with adapter
- Hand pads
- Transmitter belt
- Brackets for transmitter belt
- Short and long stick-tops
- Aluminum case
- Transmitter manual (Part 1)
- Receiver manual (optional)

The programming manual (manual part 2) can be found in its last version on **www.graupner.de** by the related item page.

Technical Data

Transmitter mc-28 HoTT

Frequency band	2,4 ... 2,4835 GHz
Modulation	FHSS
Transmitting power	100mW EIRP
Control functions	16 functions of which 4 can be trimmed
Temperature range	-10 ... +55 °C
Antenna	Patch integrated in the case
Operating voltage	3,4 ... 4,35 V (1S LiPo)
Power consumption	approx. 400 mA
Range	approx. up to 4.000 m
Dimensions	approx. 235 x 228 x 66 mm
Weight	approx. 1250g with transmitter battery



Note

The technical data of the optional receiver are available in the manual included in the receiver package content.

Symbols explication



Always observe the information indicated by this warning sign. Particularly those which are additionally marked with the **CAUTION** or **WARNING**. The signal word **WARNING** indicates the potential for serious injury, the signal word **CAUTION** indicates possibility of lighter injuries.



The signal word **Note** indicates potential malfunctions. **Attention** indicates potential damages to objects.

Safety notes



These safety instructions are intended not only to protect the product, but also for your own and other people's safety. Therefore please read this section very carefully before using the product!

- Do not carelessly leave the packaging material lying around, since it might become a dangerous toy for children.
- Persons, including children, with reduced physical, sensory or mental capabilities, or lack of experience or knowledge, or not capable to use safely the transmitter must not use the transmitter without supervision or instruction by a responsible person.
- Operation and use of radio-controlled models needs to be learned! If you have never operated a model of this type before, start carefully and make yourself familiar with the model's reactions to the remote control commands. Proceed always responsibly.
- Protect all equipment from dust, dirt, moisture. All equipment must be protected from vibration as well as excessive heat or cold. The models may only be operated remotely in normal outside temperatures such as from -10°C to +55°C.
- Always perform a range and function test on the ground before you start using your model. Only so you can grant a safe use! How to perform a range test is explained in the Part 2 of the manual.
- Only operate all your HoTT components using the current software version.
- If you have questions which cannot be answered by the operating manual, please contact us or another expert in the field.

For your safety by handling the transmitter



WARNING

Also while programming the transmitter, make sure that a connected motor cannot accidentally start. Disconnect the fuel supply or drive battery beforehand.



CAUTION

Risk of fire! Avoid every kind of short-circuit in all sockets of the transmitter! Use only the suitable connectors. In no case the electronic component of the transmitter may be changed or modified. Due to licensing reasons, any reconstruction and/or modification of the product is prohibited.



Note

During transport protect the model and the transmitter from damages.

For your safety by handling the battery



CAUTION

- Protect all equipment from dust, dirt, moisture. Only use in dry locations.
- Do not use any damaged battery. Risk of injury!
- Any alterations to the battery can cause serious injury. Risk of fire!
- Batteries may not be heated, burned, short-circuited or charged with excessive current or with reversed polarity.
- While they are being charged, the batteries must be placed on a non-flammable, heat-resistant and non-conductive surface. Combustible or highly flammable objects are to be kept away from the charging area. Batteries must be monitored while they are being charged.
- The maximum quick charging current specified for the respective cell type may not be exceeded.
- If the battery heats up above 60°C while it is being charged, stop charging and let the battery cool down to approximately 30-40°C.
- The batteries must not be modified. Do not directly solder or weld the cells.
- If handled improperly, there is a danger of fire, explosion, irritation and burns. To extinguish a fire use, water, CO², sand.
- Leaked electrolyte is caustic and should not be touched or come into contact with your eyes. In case of emergency, rinse with a large quantity of water and consult a Med. Doctor.

- Always charge the battery fully.
- The maximum charging current permitted may not be exceeded.
- Never leave the charger unattended when it is connected to the power supply.
- Batteries may only be charged in rooms fitted with smoke detector.

Safety notes for stocking LiPo / Lilo batteries

- Batteries may only be stored in non completely discharged condition.
- Batteries may only be stored in dry rooms with an ambient temperature of +5°C to +25°C.
- Stock the Lilo/LiPo batteries with a cell voltage of about 3,8V. If the cell voltage falls below 3 V, then the battery must be necessarily charged. Deep discharge and storage in discharge status (cell voltage < 3V) make the battery useless.
- Charge and transport your batteries always in a safety bag.

Description of the transmitter

Control elements on the transmitter

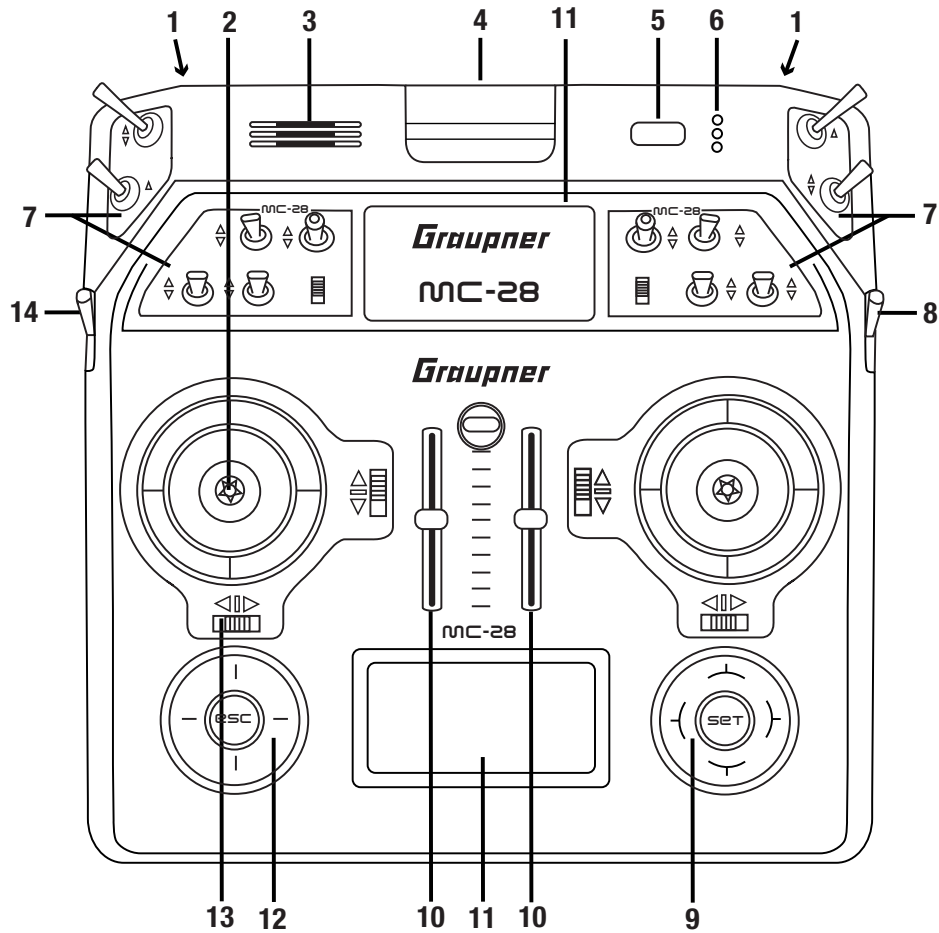

1	Connection sockets (protected by a cover)
2	Control sticks: 2 sticks for a total of 4 independent control functions
3	Speaker
4	Antenna (integrated in the case)
5	ON/OFF switch
6	LED indicators (battery, RF radiation, warning signals, charge indicator)
7	Places for switches and buttons As standard are installed: 12 switches with different designs, 2 INC/DEC buttons
8	Right rotary control "SD1"
9	Right touch pad with four-way keys
10	Slider controls "SR1" and "SR2"
11	LCD
12	Left touch pad with four-way keys
13	Digital trim
14	Left rotary control "SD2"

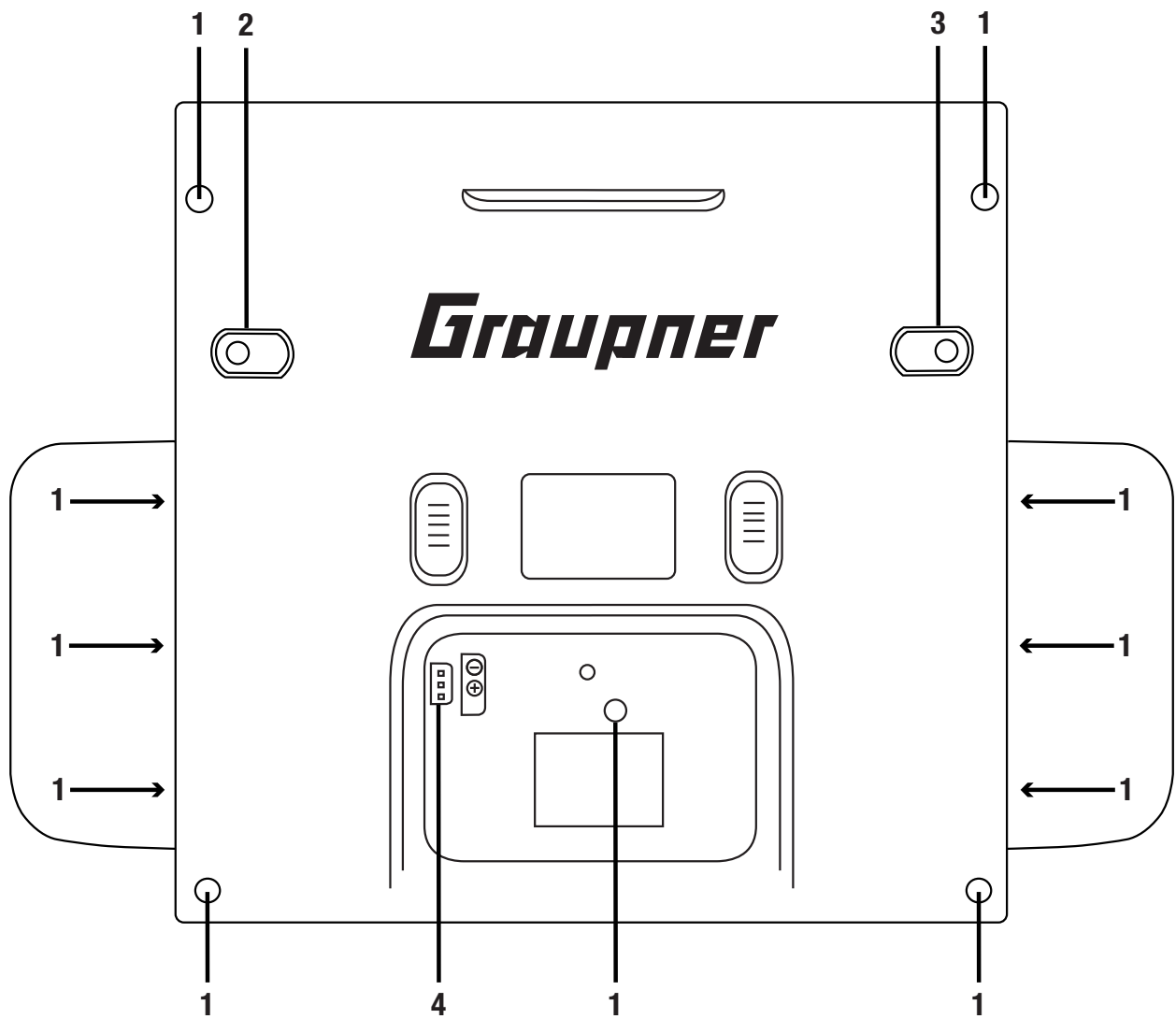

1	Five housing screws and six screws for the hand pads
2	SW16/PB18
3	SW17/PB19
4	Connection socket for transmitter battery (pay attention to the correct polarity)

Inside view

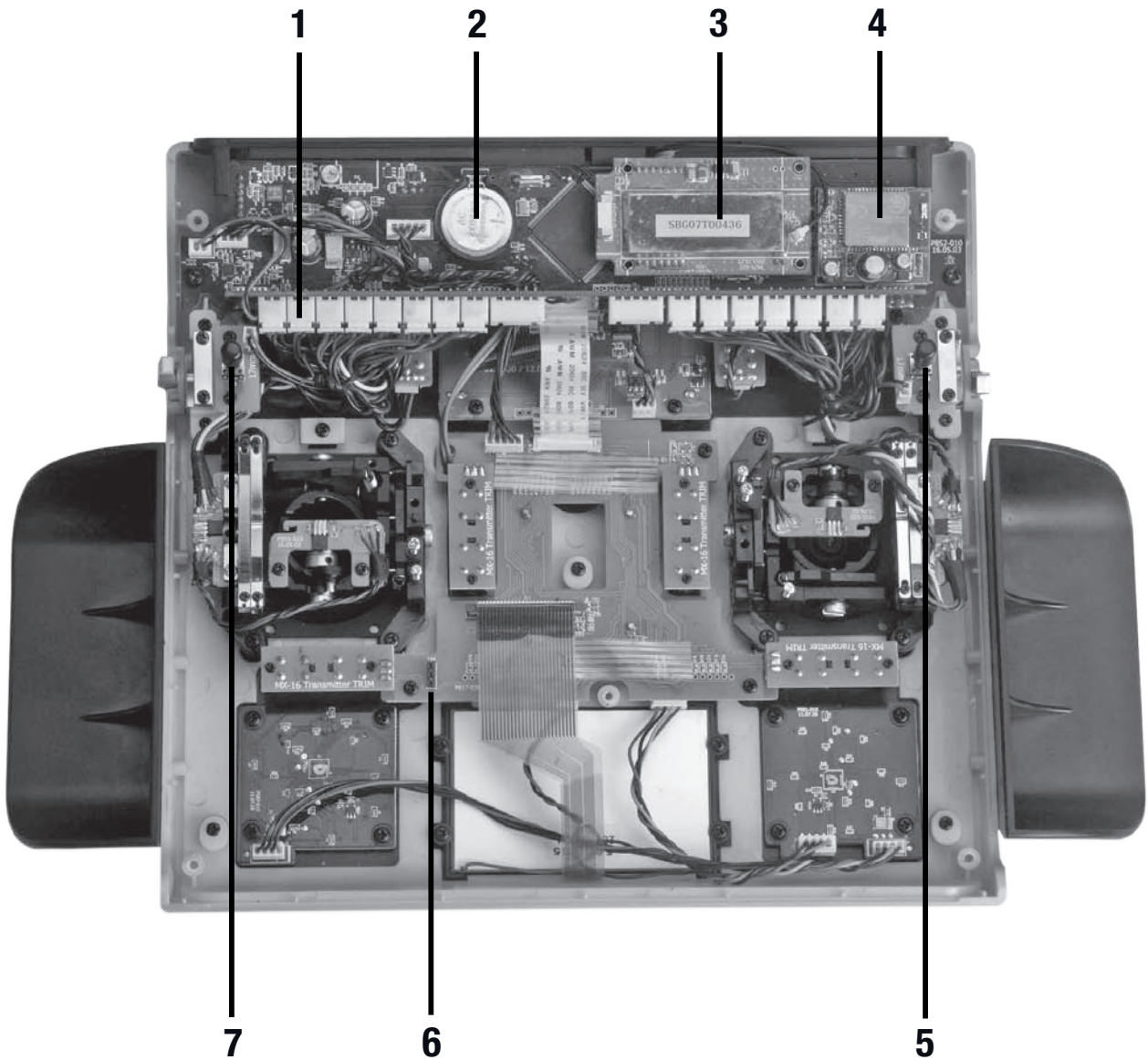

1	Sockets for optional transmitter controls and switches (connection sequence as preferred)
2	Lithium battery
3	RF module
4	Bluetooth module
5	SW17/PB19 (when transmitter is closed)
6	Transmitter battery plug
7	SW16/PB18 (when transmitter is closed)

Interfaces

Provided connection

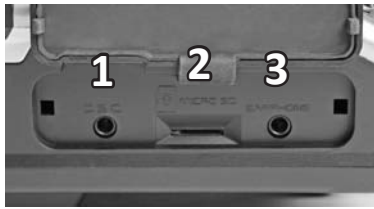

Left provided connections

1. DSC socket

On the left side is located the DSC socket. This socket allows the trainer/pupil function and the use of flight simulators.

For more information on the DSC socket and the trainer/pupil function see the section "DSC socket".

2. SD card slot

The card slot is suitable for micro SD memory card. For information on removing and inserting the memory card, refer to the section "memory cards".

3. Ear phones port

The ear phones port is suitable for a 3,5 mm jack. Though this interface both acoustic signals and voice messages are emitted.

The volume can be controlled by "Voice volume" and "Signal volume" in the general settings.

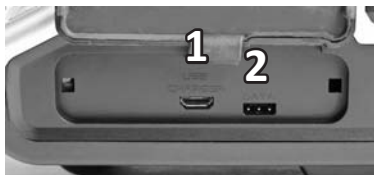

Right provided connection

1. Micro USB port / battery charge and PC connection



Note

The micro USB socket is not suitable for flight simulator connection.

As soon as you connect the USB cable to the transmitter a selection menu appears. Here you can set up the function of the micro USB port.

PC COM Port- for updates

Mass storage memory- to access to the SD card

Battery charge- only battery charging

Battery charging

Through the micro USB port you can charge the transmitter battery. Use the included USB cable to connect the transmitter to a suitable USB port and charge the transmitter battery. If the transmitter is switched on the charge time is longer than if the transmitter is switched off.

The maximum charge current is 2 A.

More information are available in the section "Charging the transmitter battery".

USB connected
►PC COM Port
Mass storage
Charge only



Note

The HV-LiPo battery reaches its full capacity only when it is externally charged at 4.35V. The internal charging voltage is limited to 4.2 V for compatibility reasons.

PC COM Port connection

Through this socket it is also possible to connect the transmitter to a PC. The software that the computer needs as well as the appropriate USB driver can be found on the download page on www.graupner.de for the respective product.

Mass storage memory

If you select this option, then you can accede from your PC directly to the SD card (if insert).

2. Data socket

The data socket is suitable for connection of an optional smart box or an external optional Bluetooth module.

DSC socket

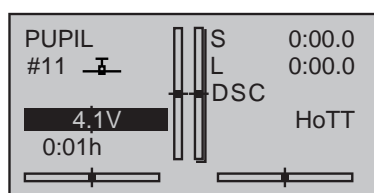

Connection socket for flight simulator or T/P systems

The standard two-pin DSC socket on the transmitter functions as a TRAINER or PUPIL socket as well as an interface for flight simulators or other external RF modules.

To ensure a correct DSC connection, observe the following:



Attention

When your transmitter is directly connected to a desktop computer by a connecting cable (DSC cable) and/or a computer interface is connected to your simulator, the transmitter may be destroyed by electrostatic discharge. This type of connection should therefore only be used if you protect yourself from electrostatic discharge while operating the simulator by wearing a commercially available grounding armband. **Graupner** therefore strongly recommends only using wireless simulators.

Perform any necessary adaptations in the menu.

The status LED is constantly red and in the display will appear DSC.

In the upper display appears the transmitter logo.

The transmitter is now ready for use.

Connect the other end of the connecting cable to the device while observing the relevant operating instructions.



Note

Make sure that all the plugs are securely inserted in the respective sockets, and only use the provided plug-in connections with a 2-pin jack plug on the DSC side.

In the "Transmitter setting" submenu, you can set one of the following modes in the "DSC output" line depending on the number of functions to be transmitted: PPM10, PPM16, PPM18 and PPM24. Default setting: PPM10.

Memory cards

Compatible memory cards

- micro SD up to 2 GB
- micro SDHC up to 32 GB

Our recommendation: For a normal use a memory card with a storage capacity of up to 4 GB is sufficient.

Inserting and removing the memory card step by step

Switch off the transmitter.

The memory card slot is located in the left provided connections of the transmitter.

To insert

Push the SD card as deep as you need to win the spring resistance of the slot. (contacts upward)

To remove

Push the SD card slightly toward the card slot to unlock it and then remove it.

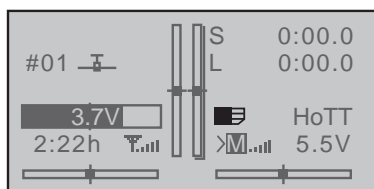

The included memory card is ready for use as soon as the transmitter is switched on. In the display appears the symbol of a memory card.

Otherwise, folders are created on the memory card (represented in the transmitter display by a permanent filling from left to right memory card). When the animation finishes, the inserted memory card is ready for use.

You can connect the memory card to your PC by using a memory card reader. Copy the data downloaded from the transmitter page on the web site in the related folder of the memory card. Insert the memory card in your transmitter.

Data recording/Data saving

The data recording in the SD card is linked to the log timer. If it is started, the data recording starts as well and it stops when the log timer is stopped.

The data writing on the memory card is remarked by the symbol of the "filling" of the memory card with black from left to right.

After the installation of the memory card, there is a folder structure in it. These folders are actually empty.

Finally, the log files are saved in subfolders called "Modelname" named according to the structure 0001_year-month-day.bin. If a

model memory is still nameless, the corresponding log files are saved in a subfolder entitled "NoName".

In the folder "Models" are saved the exported model memories.

The data can be evaluated on a compatible computer using the programs found on the downloads page for the transmitter under www.graupner.de.



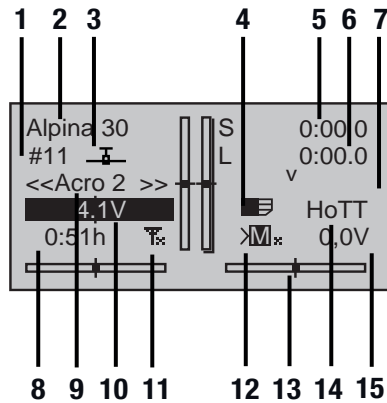

Display and touchpad



1	Model memories 1 ... 120
2	Model name
3	Model type display
4	Micro SD card (inserted)
5	Flight chronometer in min:s (forward/reverse)
6	Log timer in min:s
7	Flight phase timer display
8	Transmitter use timer
9	Phase name
10	Transmitter battery voltage with dynamic bar indicator (if the battery voltage underruns the 3.6 V (adjustable) threshold a warning message will appear and an acoustic warning will sound)
11	Signal power
12	M = Model function, P = Pupil Near: Signal strength
13	Graphic display of the position of the four digital trimming levers with a direction display.
14	Operating mode
15	Receiver battery voltage RX-VOLT



Symbols in the display

Telemetry symbols in the display

-  The active model memory has not yet been bound to a receiver.
-  Not flashing: RF transmitter function switched off.
Blinking antenna symbol: Last receiver bound to the active model memory is inactive or out of reach
-  No telemetry signal to receive
-  Signal strength display of the model connection
-  Signal strength display of the connection with pupil transmitter in the teacher transmitter display with wireless connection

Position indicator

INC/DEC buttons CTL 5 and 6

-  Once you activate one of the CTRL dials 5 + 6 in the middle of the transmitter upper part, a symbol appears on the left near the vertical trim position indicators in the lower display.
-   The symbol is a vertical bar with a horizontal line through it, positioned near the trim indicators.

Contemporaneously the vertical position indicators change during the operation from the trim position to the CTRL dials 5 + 6 indicating their actual position.

The left bar shows the position of the left INC/DEC CTRL dial 5 and the right bar shows the position of the position of the right CTRL dial 6 (both horizontal bars show the trim position of the related sticks trims).

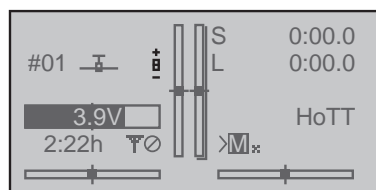

Approx. 2 seconds after the end of the operation of both buttons, the display shows again the actual trim position of the trims (elevator/nick and throttle/pitch) of the related sticks.

Key pad

The keypads of the **mc-28 HoTT** transmitter are touch-sensitive cap-touch buttons. The buttons are operated by lightly touching them.

Keys left of the display

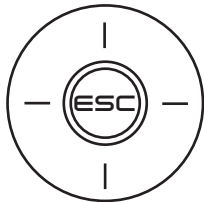

- **ESC button**

Pressing the ESC button brings about a stepwise return to function selection or back to the basic display. Any setting changed in the meantime is retained.

Momentarily touching the ESC key for about 1 second while in the base screen will open and close the Telemetry menu.

- **Selection keys** ◀▶ ⬆⬇

Momentarily pressing one of these keys will cause analogous paging in the given arrow direction through lists, e. g. through the model selection list or the multi-function list or within menus through the menu lines.

Keys to the left of the display



- **SET key**

1. Briefly pushing the SET key will cause a jump from the displayed base screen to the multi-function menu.
2. In the settings menu activate (confirm) the settings fields by pressing the SET button.

- **Selection keys** ◀▶ ⬆⬇

1. "Paging" through the multi-function menu and the menu lines within the Basic Settings menu analogous to the arrow keys of the left touch pad.
2. Select or set parameters in setting fields after they have been activated by briefly touching the SET key, whereby the ▶▲ keys and ◀▼ are used for the same corresponding functions.
3. By briefly pressing the ⬆⬇ keys simultaneously or ◀▶ an altered parameter value for the active entry field will again be restored to its default value (CLEAR).



Note

In the event the touch pads do not exhibit any functionality immediately after switching the transmitter off and then on again right away, this is not a fault. Just switch the transmitter off again then wait for several seconds before switching it on again.

Commissioning

Hand pads

Installing the hand pads

The hand pads have to be installed on the sides of the transmitter. Hold the hand pad exactly upon the six holes and fix it with the 6 fixing screws. Use the same procedure for the other hand pad.



Attention

Screw the fixing screws only with the hand pads on the transmitter case. The place inside the transmitter case will otherwise not be enough and you could damage the boards.

Removing the hand pads

The hand pads are removed by unscrewing the fixing screws. After removing the screws glue the included rubber pins on the holes. So you will protect the transmitter interior.



Attention

Do not screw the fixing screws in the holes after removing the hand pads! The place inside the transmitter case will not be enough and you could damage the boards.

Brackets for transmitter belt



Installing the metal brackets

Insert the included metal bracket in the bracket holder on the side of the transmitter.

Push the bracket against the spring (approx. 1 cm in the transmitter direction).

Contemporaneously rotate the bracket to the outside to fix it.

Proceed similarly with the second bracket.

Removing the metal brackets

Unlock a bracket, by gently pushing it inwards and then fold in the direction of the transmitter center.

Once the retaining pin is free again, you can pull the bracket away from its place.

Proceed similarly with the second bracket.

Anchorage for the transmitter belt

On the upper side of the transmitter there is an eyelet which can be used to hook a neck-strap.

Opening/closing the transmitter housing

The transmitter should be opened only in the following cases:

- If a self centering stick has to be converted in non self centering
- If a non self centering stick has to be converted in self centering
- To set the control stick centering force

Open step by step

Before opening the housing switch the transmitter off.

Open the battery case.

Remove the battery.

If the hand rests are installed: Loosen each of the three lower screws of the six fixing screws securing the hand pads.

Loosen the five case screws.

Hold both housing halves with both hands and let the screws fall on a proper surface turning the transmitter upside-down.

Rotate the lower case and lay it on one side.



Attention

Never switch the transmitter on while the housing is open! Do not touch the electronic boards.

Closing step by step

Check if the upper and the lower part of the transmitter housing are correctly coupled.

Screw the housing screws in their original position.

Connect the battery.

Install the hand pads again.

Sticks conversion

Neutralization

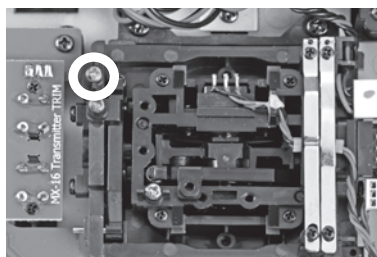

Both control sticks can be set from neutralizing to non-neutralizing.

Neutralizing step by step

Locate in the left control stick gimbal the screw surrounded by a white circle in the picture.

Turn the screw toward the inside of the transmitter until the relevant control stick can move freely from stop to stop, or turn it outward until the control stick resets itself independently.



Note

The right control stick gimbal is specular to the left one, so that here the screw is located right under the middle.

Brake spring and ratchet

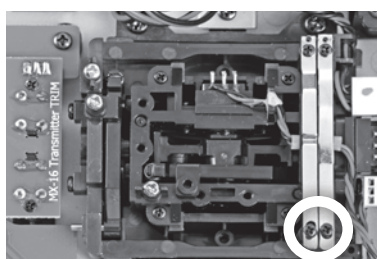

The outboard screw of the two marked in the figure adjust the braking force.

The inboard screw adjusts the strength of the ratchet for the respective control stick.



Note

The right control stick gimbal is specular to the left one, so that here the screws are located left on the top side.

Control sticks centering force

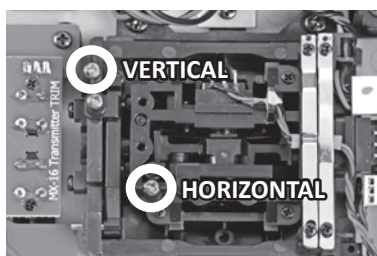

The control sticks' restoring force can also be adjusted. The adjustment is located next to the return springs.

By turning the respective adjust screw the spring force can be adjusted.

Right turn = return harder

Left turn = return softer

Control sticks length adjustment

Length of both control stick can be adjusted. Hold down the bottom half of the knurled grip, and loosen the screwed connection by turning the top part:

You can now lengthen or shorten the control stick by screwing it up or down. Then clamp the top and bottom part of the grip by rotating them against each other.

Analogously proceed with the exchange of the short sticks against the supplied longer sticks.

General commissioning



Note

As soon as the transmitter is switched on then the throttle position is checked. If the throttle position is not in the motor-off area, then the drive motor may start in an uncontrolled manner. This check is performed by all the models with the setting "Motor at CH1 front/back". The warning alarm "Throttle too high" appears. For this reason in this case the RF module will not be switched on. This check is performed for every model types. With helicopter models the warning works only if you use a Motor-off programming or if a throttle limiter is set.

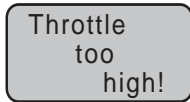

WARNING

If you do not follow the afore mentioned instructions, the connected drive motor can run accidentally when the transmitter is switched on. Risk of injury! Always program a switch for motor stop!

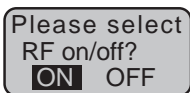



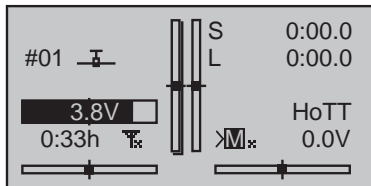

If the previously mentioned checks are passed, the RF module will be activated when the transmitter is switched on and in the display appears a selection indicator.

Select with the selection buttons of the right four way keys RF ON/OFF. By tipping the SET button on "OFF" the RF module is switched off.

The color of the lighting central LED changes to red and you are now in the transmitter main menu display.



The symbol  mean that the currently active model memory has once been linked to a receiver but is presently not linked. (We have turned the RF module off for example reasons.) If instead the transmitter was switched on without turning off the RF module, the central LED would light blue and the symbol  would blink. Contemporaneously a warning acoustic signal is emitted until a connection is established with the respective receiver. As soon as this connection is established appears a field strength indicator  and the warning signal stops.

If the telemetry connection is established the respective indication of the receiver signals strength  so as the actual receiver power supply voltage.

On the other hand, if the screen displays the symbol combination  and the center LED illuminates in red continuously then the currently active model memory is not "bound" to any receiver.

Binding a receiver

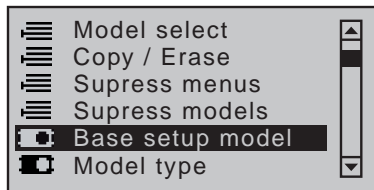

In order to be able to establish a connection to the transmitter, **Graupner**-HoTT receivers must be connected to at least one model memory of “their” **Graupner**-HoTT transmitter. This process is commonly referred to as “binding” and can be repeated at any time.

By default, this “binding” of a recipient is always model-memory-specific, but it can be changed to transmitter-specific, and vice versa, at any time and for any non-bound model memory of a transmitter in the “Binding Type” menu line.

The exact sequence of the binding process results from the combination of the description of the transmitter-side part of the binding process in Part 2 of the transmitter instructions and from the description of the receiver-specific procedure to be found in the respective receiver instructions.

Principal procedure step-by-step

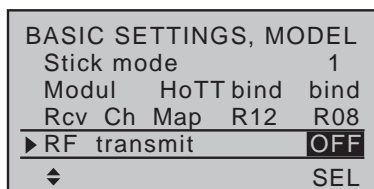

1. Bring transmitter and receiver at a moderate distance from each other.
2. If necessary, switch on the **mc-28 HoTT** transmitter without RF or set the RF module in the “RF module” line of the “Basic setup model” menu to “OFF”.
3. If necessary select the »Basic setup model« menu in the transmitter.
4. Touch the ENT key.
5. Change to the “Module” line with the selection buttons.
6. Switch on the power supply of the receiving system.
7. ...

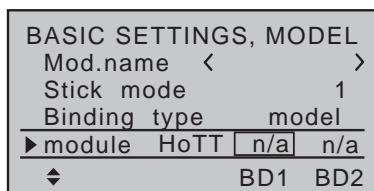

... receiver with SET button

Press the SET button on the receiver for approx. 3 seconds.

... receiver without SET button

The receiver automatically switches to binding mode after switching on. Details can be found in the corresponding description.

8. Touch the ENT button on the transmitter to initiate the transmitter-side binding process.

If the LED of the receiver indicates, according to its description, correct connection and in the value field of the line “module” the receiver abbreviation appears, the binding process was completed successfully. Otherwise, the positions of the devices may have to be changed and the entire procedure must be repeated.

Adjust control mode

BASIC SETTINGS, MODEL			
Mod.name	<	>	
▶ Stick mode			1
module	HoTT	bind	n/a
Rcv Ch	Map	R12	n/a
◆			SEL

By default, the transmitter is supplied with the software control mode 1. Accordingly, each newly created model memory is initialized with the control mode 1.

However, this default value can be adapted to your own habits at any time in the "Stick mode" line of the "Basic setup model" menu.

Change stick mode step-by-step

1. Change to the »Basic setup model« menu.
2. Move into the line "Stick mode".
3. Press the ENT key.
4. Select the desired control mode with the selection buttons
5. Press the ENT key.
6. Exit the menu by pressing the ESC key.

The following control modes are available



(Airplanes)

MODE 1 (Throttle right)	MODE 2 (Throttle left)
<div style="display: flex; justify-content: space-around;"> <div style="text-align: center;"> <p>Elevator</p> <p>Rudder</p> </div> <div style="text-align: center;"> <p>Full throttle</p> <p>Querrudder</p> </div> </div> <div style="display: flex; justify-content: space-around; margin-top: 10px;"> <p>Elevator</p> <p>Motor idle</p> </div>	<div style="display: flex; justify-content: space-around;"> <div style="text-align: center;"> <p>Full throttle</p> <p>Rudder</p> </div> <div style="text-align: center;"> <p>Elevator</p> <p>Aileron</p> </div> </div> <div style="display: flex; justify-content: space-around; margin-top: 10px;"> <p>Motor idle</p> <p>Elevator</p> </div>
MODE 3 (Throttle right)	MODE 4 (Throttle left)
<div style="display: flex; justify-content: space-around;"> <div style="text-align: center;"> <p>Elevator</p> <p>Aileron</p> </div> <div style="text-align: center;"> <p>Full throttle</p> <p>Rudder</p> </div> </div> <div style="display: flex; justify-content: space-around; margin-top: 10px;"> <p>Elevator</p> <p>Motor idle</p> </div>	<div style="display: flex; justify-content: space-around;"> <div style="text-align: center;"> <p>Full throttle</p> <p>Aileron</p> </div> <div style="text-align: center;"> <p>Elevator</p> <p>Rudder</p> </div> </div> <div style="display: flex; justify-content: space-around; margin-top: 10px;"> <p>Motor idle</p> <p>Elevator</p> </div>



(Helicopter)

MODE 1 (Throttle right)	MODE 2 (Throttle left)
<div style="display: flex; justify-content: space-around;"> <div style="text-align: center;"> <p>Nick</p> <p>Tail rotor</p> </div> <div style="text-align: center;"> <p>Motor / Pitch</p> <p>Roll</p> </div> </div> <div style="display: flex; justify-content: space-around; margin-top: 10px;"> <p>Nick</p> <p>Motor / Pitch</p> </div>	<div style="display: flex; justify-content: space-around;"> <div style="text-align: center;"> <p>Motor / Pitch</p> <p>Tail rotor</p> </div> <div style="text-align: center;"> <p>Nick</p> <p>Roll</p> </div> </div> <div style="display: flex; justify-content: space-around; margin-top: 10px;"> <p>Motor / Pitch</p> <p>Nick</p> </div>
MODE 3 (Throttle right)	MODE 4 (Throttle left)
<div style="display: flex; justify-content: space-around;"> <div style="text-align: center;"> <p>Nick</p> <p>Tail rotor</p> </div> <div style="text-align: center;"> <p>Motor / Pitch</p> <p>Tail rotor</p> </div> </div> <div style="display: flex; justify-content: space-around; margin-top: 10px;"> <p>Roll</p> <p>Motor / Pitch</p> </div>	<div style="display: flex; justify-content: space-around;"> <div style="text-align: center;"> <p>Motor / Pitch</p> <p>Roll</p> </div> <div style="text-align: center;"> <p>Nick</p> <p>Tail rotor</p> </div> </div> <div style="display: flex; justify-content: space-around; margin-top: 10px;"> <p>Motor / Pitch</p> <p>Nick</p> </div>



(Copter)

MODE 1 (Throttle/Pitch right)	MODE 2 (Throttle/Pitch left)
<p>Diagram for Mode 1 (Throttle/Pitch right) showing stick axes: Throttle/Pitch (up/down), Nick (left/right), Roll (left/right), and Yaw (left/right).</p>	<p>Diagram for Mode 2 (Throttle/Pitch left) showing stick axes: Throttle/Pitch (up/down), Nick (left/right), Roll (left/right), and Yaw (left/right).</p>
MODE 3 (Throttle/Pitch right)	MODE 4 (Throttle/Pitch left)
<p>Diagram for Mode 3 (Throttle/Pitch right) showing stick axes: Throttle/Pitch (up/down), Nick (left/right), Roll (left/right), and Yaw (left/right).</p>	<p>Diagram for Mode 4 (Throttle/Pitch left) showing stick axes: Throttle/Pitch (up/down), Nick (left/right), Roll (left/right), and Yaw (left/right).</p>



(Land and water vehicles)

MODE 1 (for/backward right)	MODE 2 (for/backward left)
<p>Diagram for Mode 1 (for/backward right) showing stick axes: forward/backward (up/down), left/right (left/right), and forward/backward (up/down).</p>	<p>Diagram for Mode 2 (for/backward left) showing stick axes: forward/backward (up/down), left/right (left/right), and forward/backward (up/down).</p>
MODE 3 (for/backward right)	MODE 4 (for/backward left)
<p>Diagram for Mode 3 (for/backward right) showing stick axes: forward/backward (up/down), left/right (left/right), and forward/backward (up/down).</p>	<p>Diagram for Mode 4 (for/backward left) showing stick axes: forward/backward (up/down), left/right (left/right), and forward/backward (up/down).</p>

Charging the transmitter battery

You have two charge possibilities

1. Removing the battery from its case and charging it with a charger



WARNING

The charger should always be supervised during charge and it should be used only in rooms fitted with a smoke detector.

Removing transmitter battery

Remove the battery case cover. Then remove and disconnect the battery plug by carefully pulling on the supply cable.

Charge the battery following the charger manual.

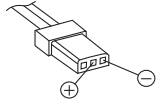

Inserting the transmitter battery

Connect the battery plug in the transmitter socket. Make sure that the polarity is correct. Pay attention to the respective "+" and "-" symbols near the socket.

Red= „+“ Black/brown = „-“

Place the battery into its compartment and close the cover.

2. Through the USB port by charging with USB cable

The transmitter battery can be charged by the current supplied by the USB port (5 V/max. 2 A).

Connect the transmitter to a USB port in your PC using the included micro USB cable or a USB net charger.

Low voltage warning

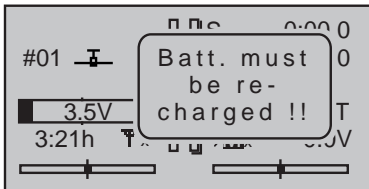

The transmitter battery voltage should be monitored in the display during operation. In case the voltage drops under a preset threshold, standard setting 3,6 V, an acoustic warning signal is emitted and in the display appears in a window "battery needs charging".

Now at the latest, stop operation and recharge the transmitter battery!

Battery use timer in the display

The battery use timer is shown in the lower left part of the display. The battery use time is added at every use. After every charge the timer is reset to "00:00". This happens only if the battery voltage increases at least of 0,3V or if the battery is full.

Switch off the transmitter

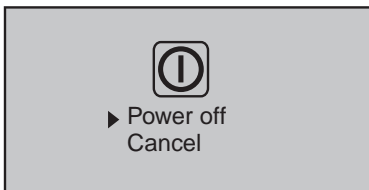

If you push on the POWER button, by switched on transmitter, for more than 2 sec. a safety query appears (see image). Select the desired option with one of the pouch pads (up or down) and push the SET button.

This safety query avoids an accidental switch off of the transmitter while in use.



Lithium battery

On the transmitter board there is a fixture for a replaceable lithium battery of type CR 2032. This battery maintains the date and time settings during a transmitter power supply outage.

Short-Cuts

The following key combinations can be used to directly call up certain menus and options:

- **CLEAR**

Brief simultaneous touch of the  keys or  on the right four way keys will restore the active entry field's changed parameter value back to its default value.

- **"Servo screen"**

Brief simultaneous activation of the  keys of the left four-way keys will cause a jump from the transmitter's base screen or from almost any menu position to the "Servo display" menu,

- **"Telemetry" menu**

Press the center ESC key in the left four-way keys for about 1 s to call up the "Telemetry" menu from the transmitter's base screen. To come back to the base screen it is enough a "normal" touch on the ESC key.

- **Graphic display of telemetry data**

Briefly touching one of the arrow keys of the left or right four-way keys will cause a jump from the base screen directly to the transmitter's graphic display of telemetry data or will allow paging back and forth between individual graphic displays.

Briefly touching the ESC or SET key will cause a return back to the base screen.

- **"HIDDEN MODE"**

Press and hold arrow keys  of the left four-way keys then momentarily touch the SET key of the right four-way keys.

- **Entry lock**

Entry lockout is activated and deactivated from the base screen by simultaneously pressing the ESC and SET keys for a little longer. The entry lock function is displayed by a key symbol: 

The controls remain operational.

Press the ESC and ENT buttons again for about two second to release the lock.

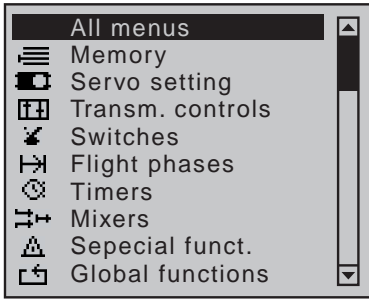

• Quick-Select

From the multi-function list, a jump can be made to a "Structure overview" by a simultaneous touch on the \blacklozenge or \blacktriangleleft keys of the right four-way keys.

Menus are arranged in clear groups in this overview.

Select the desired group with the \blacklozenge selection keys and confirm this selection with the SET key.

Only the menu points associated with the selected preamble are shown.

Select the desired menu point with the selection keys and confirm with the SET key.

The description of the single menu point is available in the programming manual (Manual part 2) on www.graupner.de.

Hidden menu options

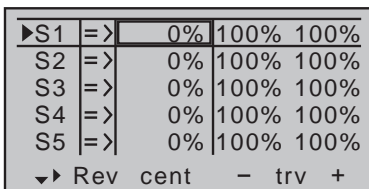

In some menus specific setting options are available but hidden. These options are marked with a triangle oriented to the right in the low left corner of the display. In the left represented menu the section "- limit +" on the right of the "- trvl. +" is hidden.

View hidden sections

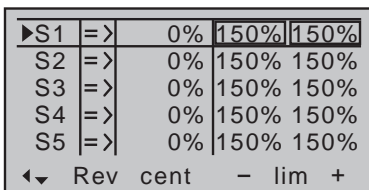

Follow the triangle oriented to the right in the lower part of the display, in which you skip the selection frame with the selection key \blacktriangleright over the section "- trvl. +" to the right.

To come back to the "- trvl. +" or more to left, follow the triangle oriented to the left, on which you can move the selection frame moving the related selection key to the left.

Use the same procedure for the other menus.

Function field in the display

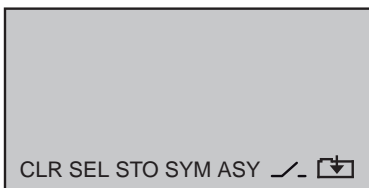

Depending on the given menu, certain function fields will appear on the bottom display line.

A marked function is activated by pushing the SET key.

CLR (clear)	Delete
SEL (select)	Selection
SET (set)	Setting
STO (store)	Store
SYM	Set values symmetrically
ASY	Set values asymmetrically
\swarrow	Switch symbol field (assignment of all types of switches)
$\square \downarrow$	Within a menu, change to the next page

Hidden mode

The "Hidden Mode" menu can be accessed from almost any menu item by pressing the SET button while holding down the selection keys  of the left four-way button.

Announcements

These messages are in German by default. These announcements are summarized in a voice packet which is stored in a transmitter-internal memory but they can be replaced by a voice packet of a different language at any time.

Here you can load user's voice files in the transmitter. These packets must be created in the "Firmware upgrade studio" with your .wad files and they must be saved in your SD card.

On the included micro SD card are already available the following languages: German, English, French, Dutch, Italian and Spanish, Czech and Russian.

The most actual language packets are available on www.graupner.de.

Language change

Language change step by step

Insert the included memory card in its slot as described in the "Memory card" section.

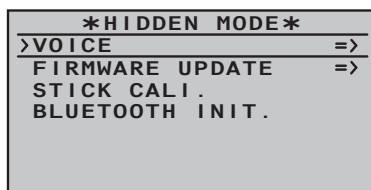

Switch the transmitter on with the RF module on.

Change in the "Secret mode" menu.

Move to the line "ANNOUNCEMENT" by using the selection keys.

Select the "ANNOUNCEMENT" option with the SET key.

Select the language or your voice files packet through the selection keys.



Confirm by pressing the SET key. The selected language packet will be stored in the transmitter memory.

The loading process is finished as soon as the progress bar at the lower edge of the display disappears.

When this process is finished, switch the transmitter off.



Notes

- If the warning message "RF OFF OK", the RF module is still active. Switch the RF module off and repeat the process.
- If the data list is empty. the transmitter is not finding any valid language data in the SD card. Verify the content of the "Voice-File" folder in the SD card by a PC.

Firmware update/Changing the display language



Note

- Before each update, check the transmitter battery charge or charge it as a precaution, and save all model memories so that they can be restored if necessary.
- Follow the "Firmware update step by step" manual steps from the section "Firmware update" "Update per memory card".

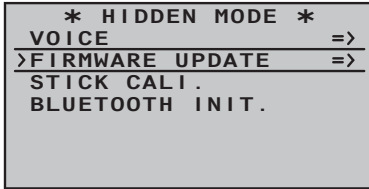

Firmware update step by step

Move with a short pressure on the SET key to the selection page of the option "FIRMWARE UPDATE".

Select the firmware version with the selection keys.

Confirm by pushing the SET key.

The storing in the transmitter memory will start:

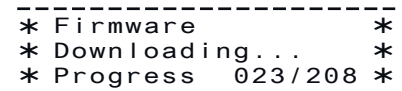
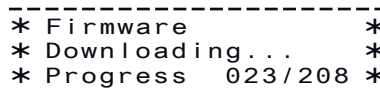
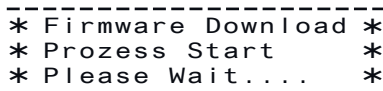

When the counter reaches the storing amount the storage process is finished and the message "Firmware upgrade success!" appears.

Stick calibration

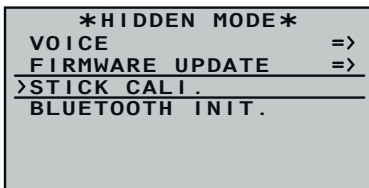

If you feel that the middle and end positions of the self-neutralizing sticks and / or the proportional sliders do not exactly correspond to 0 or 100% encoder travel, then you can check and correct this yourself.

Stick calibration step by step

1. In the "Model Selection" menu, initialize a free model memory with a model type with four control functions.
2. Assign both the center and side proportional sliders to a free control channel in the »Transmitter Setting« menu. Preferably, the channels 5 ... 8.
3. If necessary assign existing rotary controls to further control channels.
4. Do not carry out any further programming and do not adjust the trims.
5. By simultaneously pressing the ◀▶ buttons on the left four-way button, call up the »Servo display«.
6. Move each stick and each of the four proportional slides one by one to the center position and to each stop position, and check that the % values correspond to the set points of 0, -100% or +100%.
7. ...
... result in these values, there is no further need for action and the just initialized model memory can be deleted as a result.

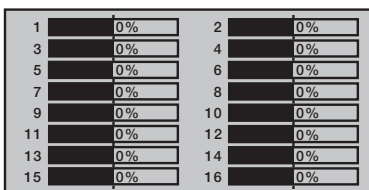

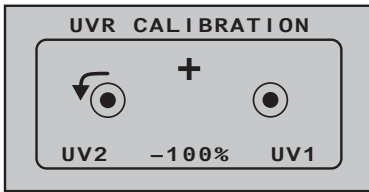
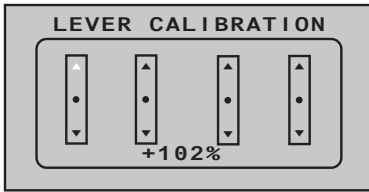
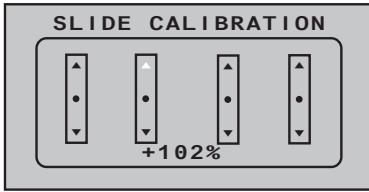
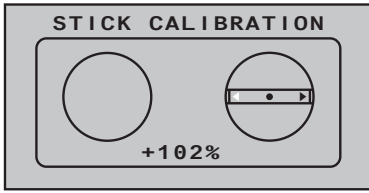
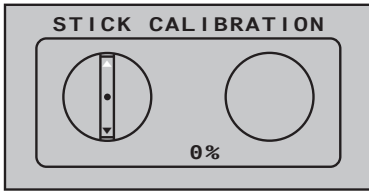

... if you do not reach the desired values, go to the "Stick Calibration" line of the "HIDDEN MODE" menu and then press the SET button.

|| The symbol of the encoder position to be calibrated flashes in the transmitter display in white.

8. If necessary cyclically select the encoder to be calibrated with the selection keys ◀▶ of the right four-way key.
9. If necessary use the selection buttons ⬆ on the right four-way button to select the control position to be calibrated.
10. Move the selected control to the appropriate position.
11. Press the SET key.
12. If necessary proceed analogously with other control positions.
13. Pressing the ESC key ends the "STICK CALIBRATION"

Bluetooth initialization

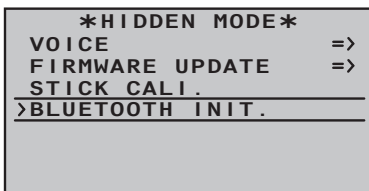

In this display you can initialize an optional Bluetooth module following the manual included in the module package content.

Telemetry data display

Sensors

The upper display serves as graphical representation of the telemetry data.

If a receiver is bound the telemetry display appears. By tipping again the selection keys ⬆, you can select which sensor or module you want to be displayed.

If instead . . . there are two "X" in the lower part of the display and it appears the message "CAN'R RECEIVE ANY DATA", it means that there is no connection between receiver and transmitter and that no telemetry data is available. Turn on your receiver, or bind a receiver to the active model memory.

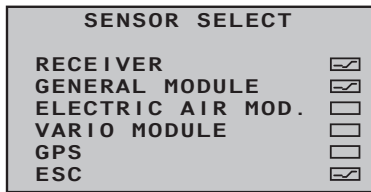

Receiver

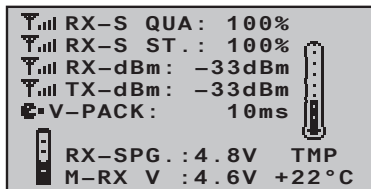

Depending on the connected modules and sensors, several selectable displays will appear. The description of these displays is contained in the manual included in the sensor package.

The transmitter recognizes automatically the sensors. You can view the sensors by changing from the main menu to the telemetry menu. The sensors will be listed in the display and marked with a checkmark.

This display offers a graph of the data from the display "RX DATA-VIEW" of the "Telemetry" menu "SETTINGS, DISPLAYS".

Value	Explanation
RX-S QUA	Quality expressed as a percentage of the signal packages from the transmitter arriving at the receiver
RX-S ST	Signal strength expressed in percentage of the signal from the transmitter arriving at the receiver
RX-dBm	Level in dBm expressed as the percentage of the transmitter signal arriving at the receiver
V PACK	Level in dBm expressed as the percentage of the receiver signal arriving at the transmitter
TX-dBm	Shows the longest time in ms in which the data packets are lost during a transmission from the transmitter to receiver
RX-VOLT	Current operating voltage of the receiver power supply in Volts
M-RX V	Lowest operating voltage of the receiver power supply since the last startup in Volts
TMP	The thermometer visualizes the current operating temperature of the receiver





Firmware update

The programs and files which are also required for updating the transmitter combined into one software package can be downloaded from **www.graupner.de**.

Download this software package from the Internet, and unpack it on your computer. All other information can be found in internet in the same page where the software package is available.

Firmware updates of the transmitter can be performed in two ways.

- Update through memory card
- Update through USB port



Notes

- Please note that compatible firmware is required for reliable communication between the HoTT components. The programs and files that are required to update are therefore combined into a single file and can be found on the Internet at **www.graupner.de** on the corresponding product page.
- These information can also be found at: **www.graupner.de** => Service & Support => Update and revision history for **Graupner** HoTT components.
- Before each update, check the transmitter battery charge or charge it as a precaution, and save all model memories so that they can be restored if necessary.
- Do not disconnect the link to the computer during an update! Make sure that the link between the transmitter and computer is operational.
- After each update, check to make sure that the models function correctly.

Update through memory card

Download the actual software package from the Internet, and unpack it on your computer. Insert the supplied mini SD Card in the card slot of your PC and copy the required firmware file from the unpacked software package into the directory "Firmware" on the memory card. Then, remove the memory card from the PC and insert it in the card slot of the transmitter. Switch on the transmitter and the RF module off.

Go to the submenu "FIRMWARE UPDATE" in the menu "Hidden mode" and proceed as described in the "Hidden mode" section.

Update through USB port

Download the actual software package from the Internet, and unpack it on your computer. Connect your switched off transmitter with your PC, by using the included USB cable, which is supplied with the package content, plug USB cable directly to the micro USB port of the transmitter and the other end to a free port in your computer. All other information can be found in the instructions that come in the software package.

Problems during firmware update

POWER switch without function

If a firmware update for the transmitter is unsuccessful or the transmitter program freezes and the transmitter cannot be turned off using the "POWER" switch, then remove the transmitter's battery after setting the switch to "POWER = OFF" position, or pull the plug from the transmitter battery, reconnect it after few seconds and leave the transmitter switched OFF.

Download the most recent update file from the Internet and save the file in the "RECOVERY" folder in your SD card.

Then change the file name in "R280.bin".

Insert the SD card in the transmitter.

Push and hold the Ctl 5 and Ctl 6 buttons at the same time to the top and push the Power button.

Now pull the Ctl 5 and Ctl 6 buttons within 2- 3 sec. to you and keep them in that position for about 10 sec.

Wait at least 30 sec. On the display there will be no image. During the update the transmitter cannot be switched on.

After 30 sec. switch the transmitter on.



SIMPLIFIED DECLARATION OF CONFORMITY

Graupner/SJ hereby declares that the transmitter **33028 Graupner mc-28 HoTT** complies with the directive 2014/53/EU.

The full text of the EU Declaration of Conformity is available at the following Internet address: **www.graupner.de**

Manufactured by

Graupner Co., Ltd
Post Code: 14557
8th F, 202 Dong, Chunui Techno-Park II, 18, 198 Street
Bucheon-ro, Wonmi-Gu, Bucheon-Shi, Gyeonggi-do
South Korea

Notes on environmental protection



This symbol on the product, user manual or packaging indicates that this product must not be disposed of with other household waste at the end of its life. It must be handed over to the applicable collection point for the recycling of electrical and electronic equipment.

The materials are recyclable as marked. By recycling, material reusing or other forms of scrap usage you are making an important contribution to environmental protection.

Batteries and accumulators must be removed from the device and disposed of at an appropriate collection point. Please inquire if necessary from the local authority for the appropriate disposal site.

Care and maintenance



The product does not need any maintenance, it works so as it is without any special care. In your own interests protect it from dust, dirt and moisture.

Warranty

The **Graupner/SJ** GmbH, Henriettenstrasse 96, D-73230 Kirchheim/Teck, Germany, grants from the date of purchase of this product for a period of 24 months. The warranty applies only to the material or operational defects already existing when you purchased the item. Damage due to misuse, wear, overloading, incorrect accessories or improper handling are excluded from the guarantee. The legal rights and claims are not affected by this guarantee. Please check exactly defects before a claim or send the product, because we have to ask you to pay shipping costs if the item is free from defects.

The present construction or user manual is for informational purposes only and may be changed without prior notice. The current version can be found on the Internet at **www.graupner.de** on the relevant product page. In addition, the company **Graupner** has no responsibility or liability for any errors or inaccuracies that may appear in construction or operation manuals.

No liability can be accepted for printing errors.

